



成都中科星驰科技有限公司

技术规格书

标准增益喇叭天线

项目	指标	单位
型号	ZK-KDLB20180	
频率	2-18	GHz
增益	12 典型值	dB
驻波	1.5 典型值	
极化方式	线极化	
接头	N-50K	
功率	150 最大	
材料	铝	
颜色	海灰色	
尺寸	126*104*78	mm



成都中科星驰科技有限公司

外形图:

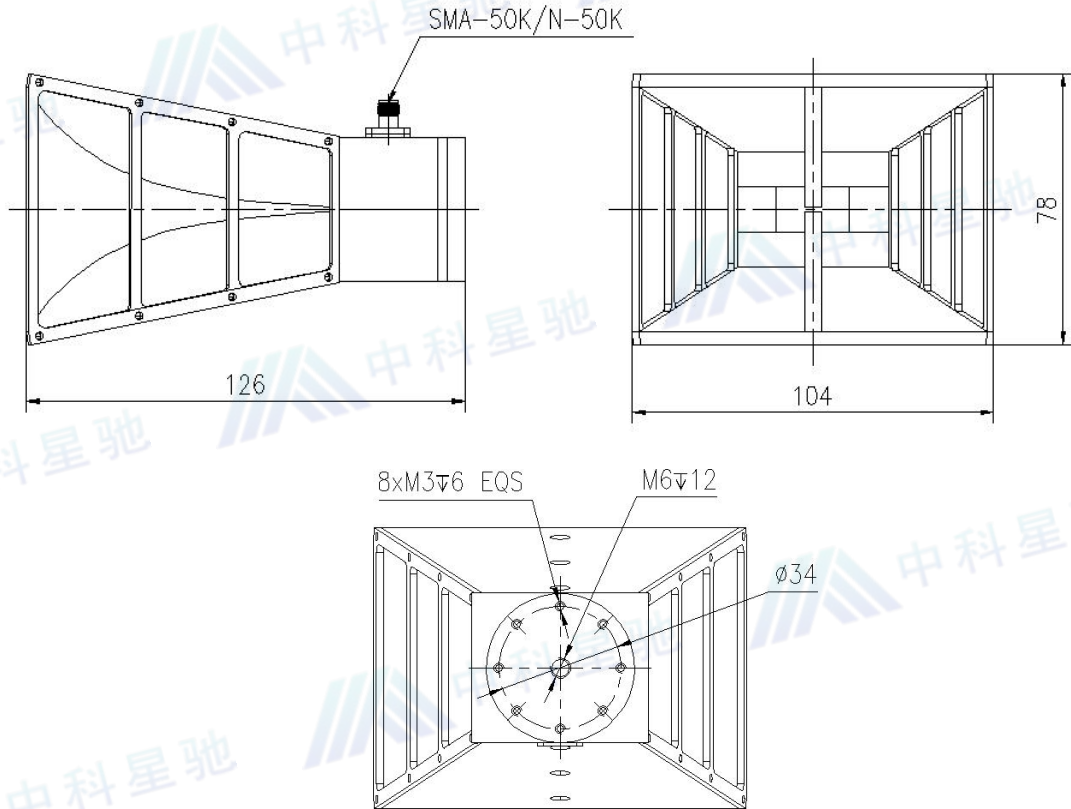

驻波:

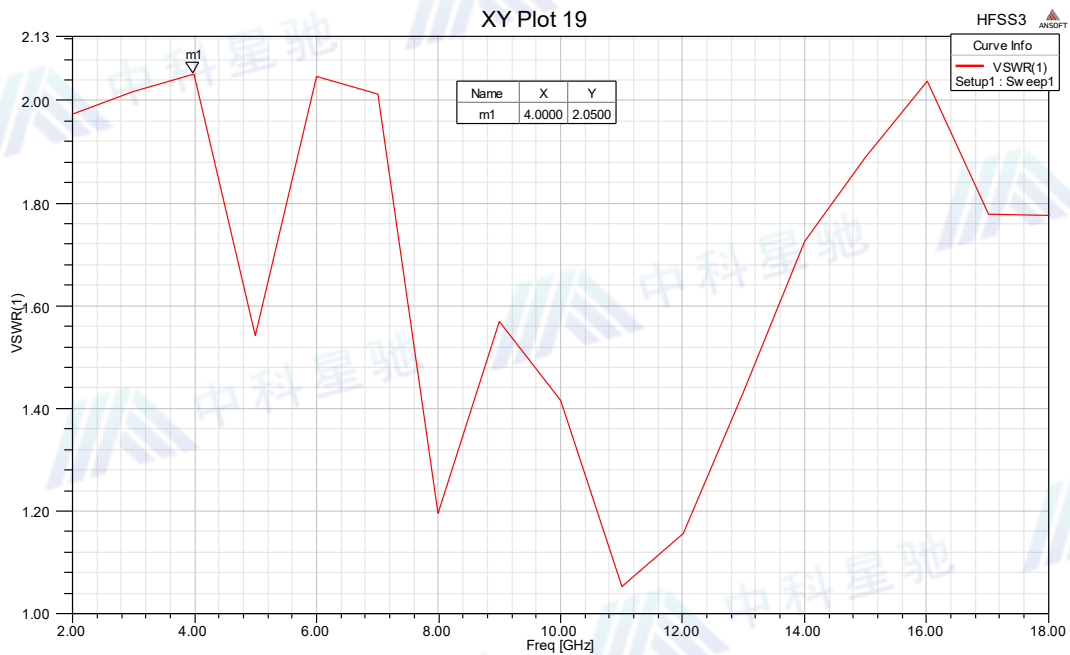



成都中科星驰科技有限公司

增益:

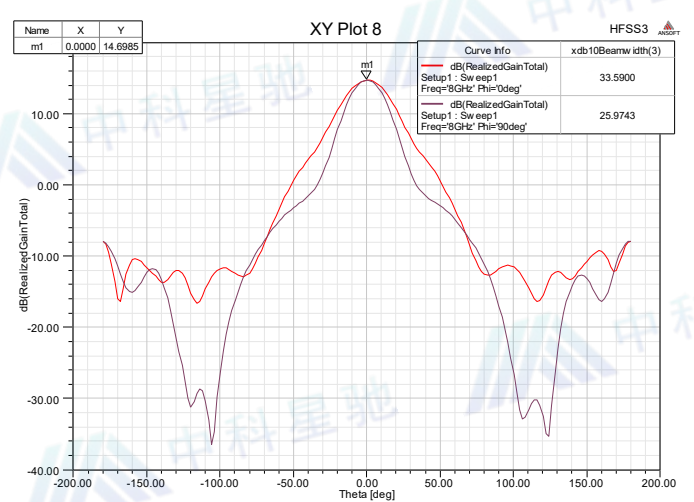
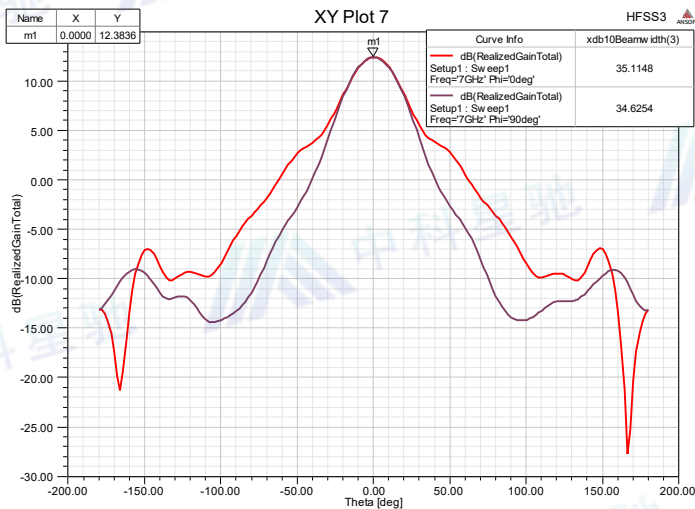
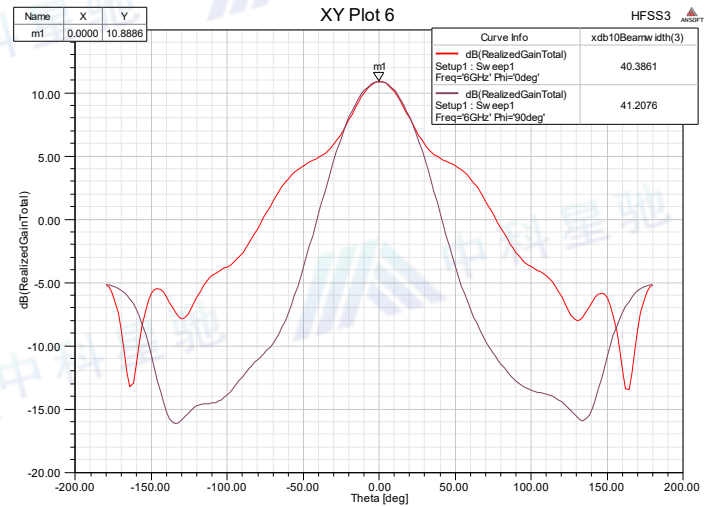
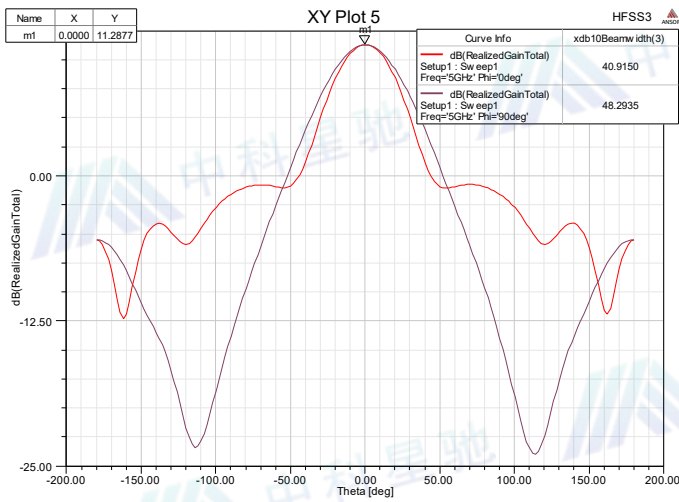
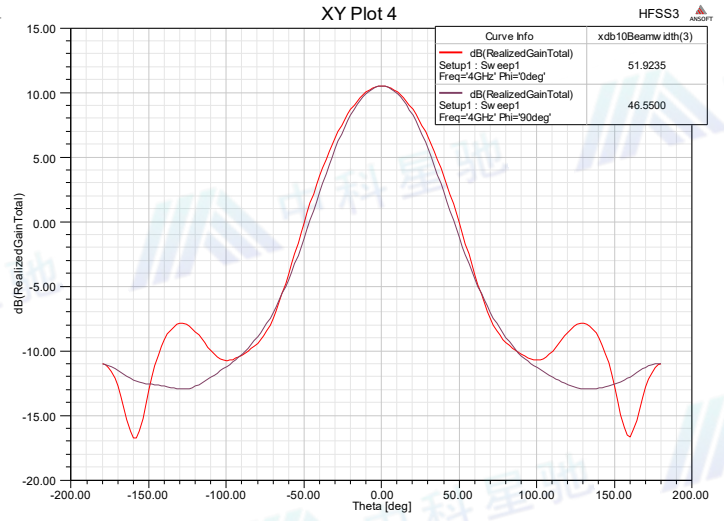
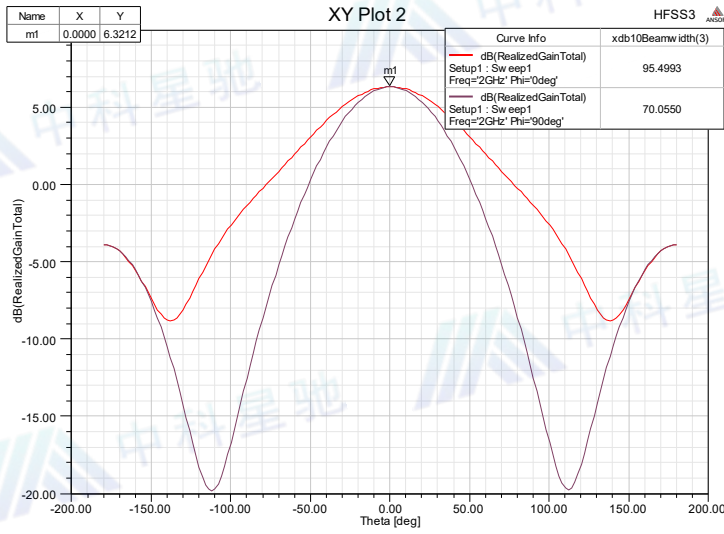



成都中科星驰科技有限公司

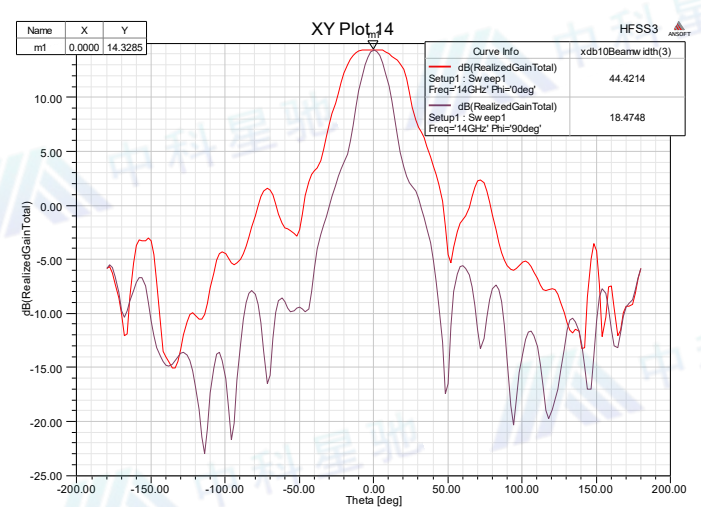
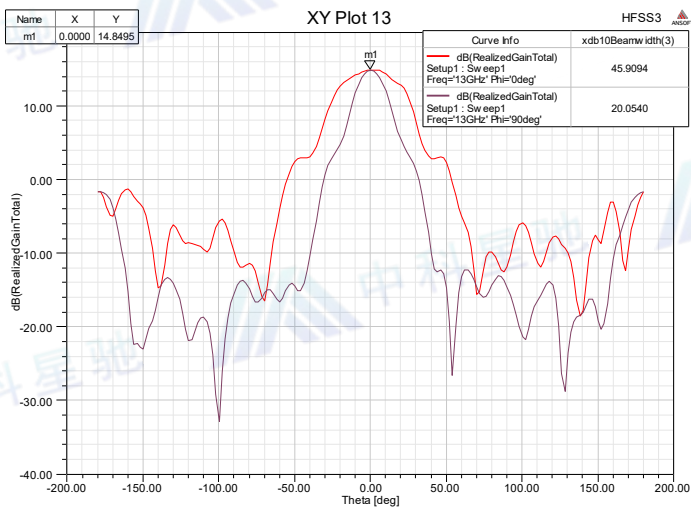
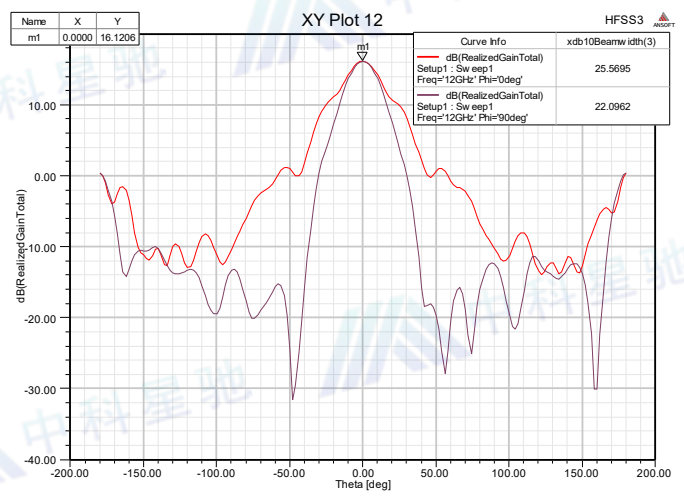
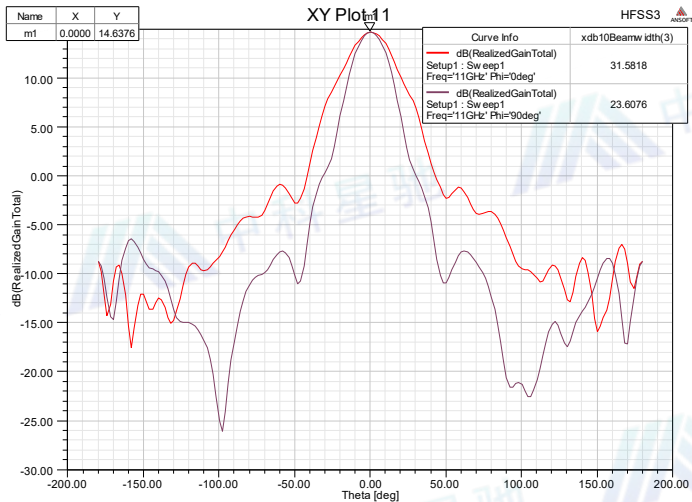
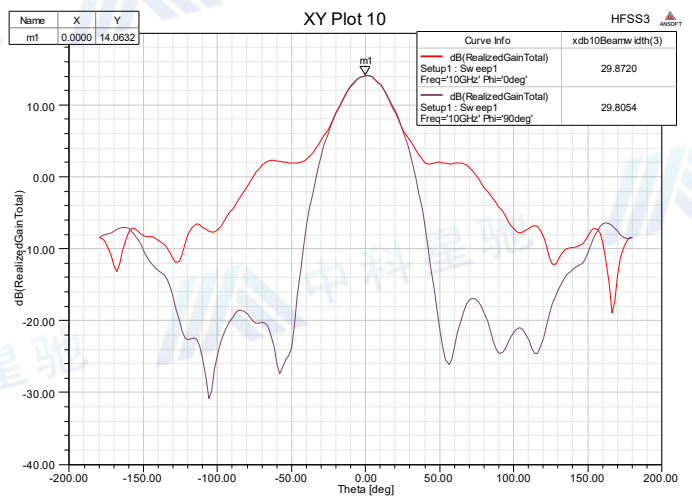
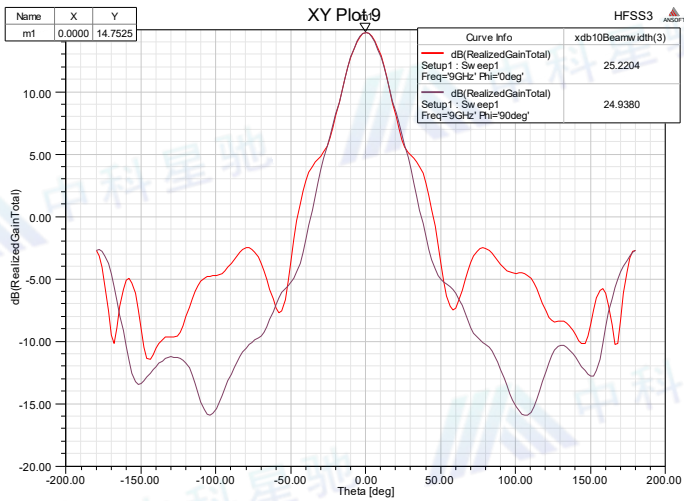



成都中科星驰科技有限公司

