

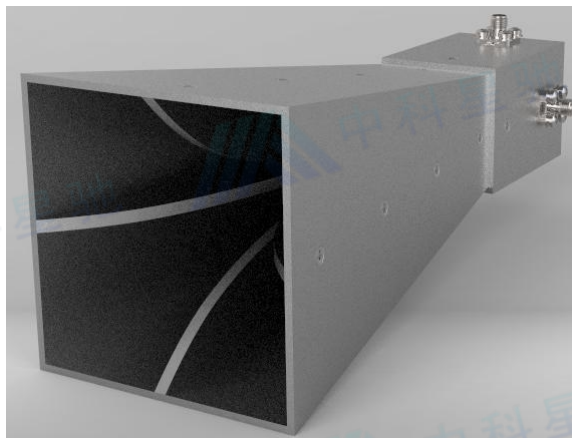

技术规格书

双极化喇叭天线

项目	指标	单位
型号	ZK-SJLB10180	
频率	1-18	GHz
增益	≥ 12	dB
驻波	2 典型值	
极化方式	双线极化	
接头	SMA-50K	
功率	50 最大	
材料	铝	
颜色	海灰色	
尺寸	316*177*177	毫米





成都中科星驰科技有限公司

外形图:

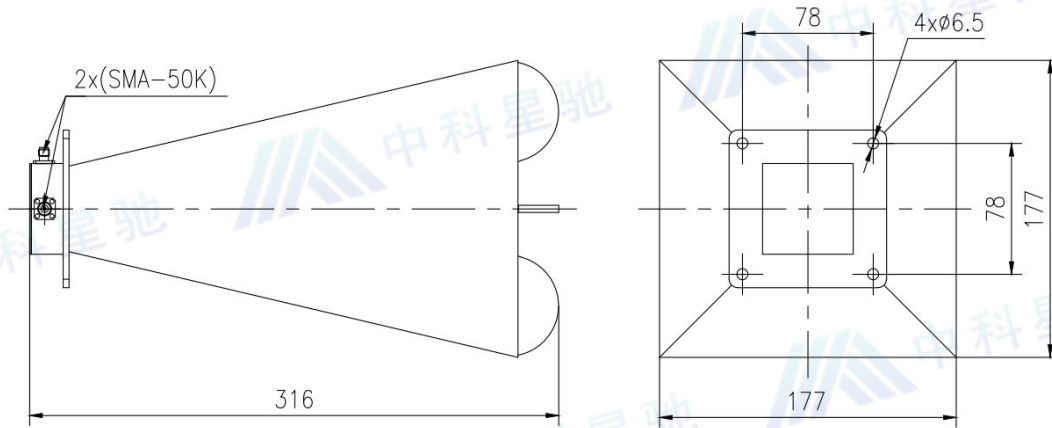

驻波:

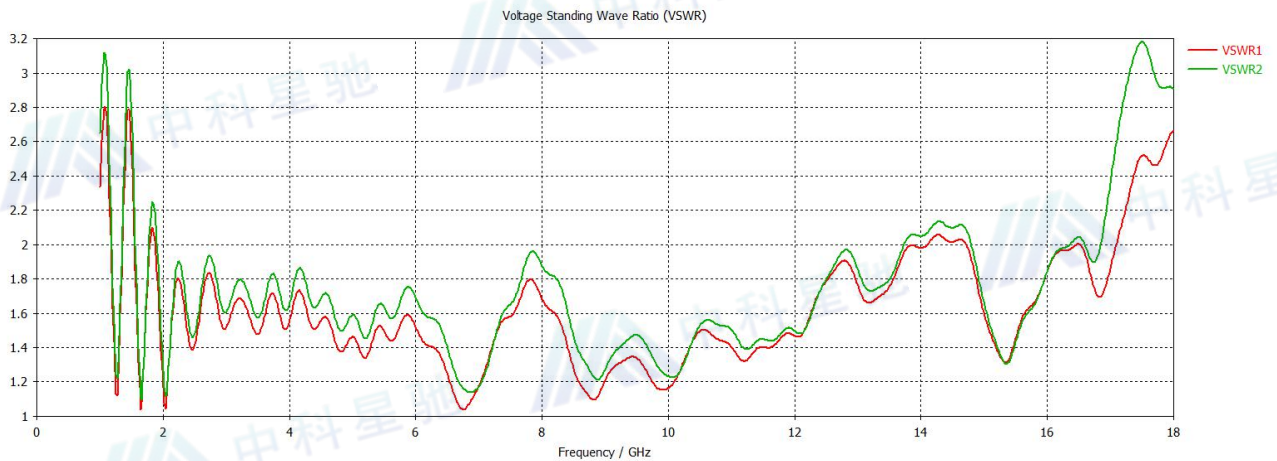



成都中科星驰科技有限公司

增益:

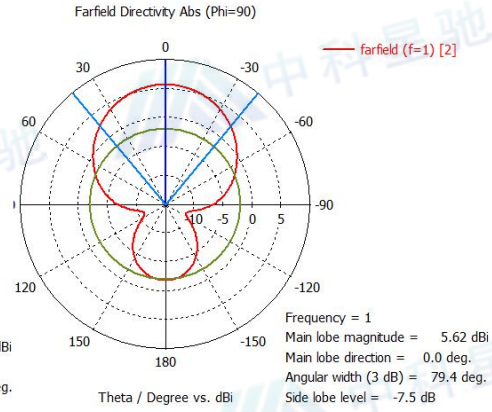
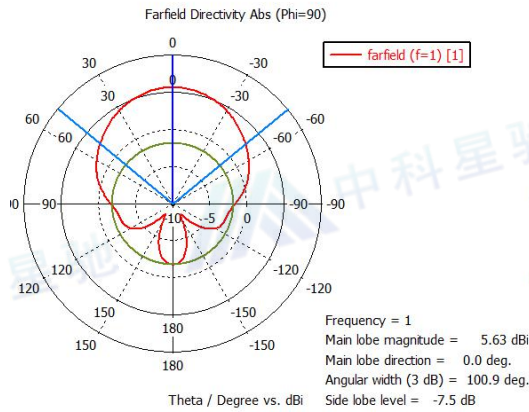

@1GHz

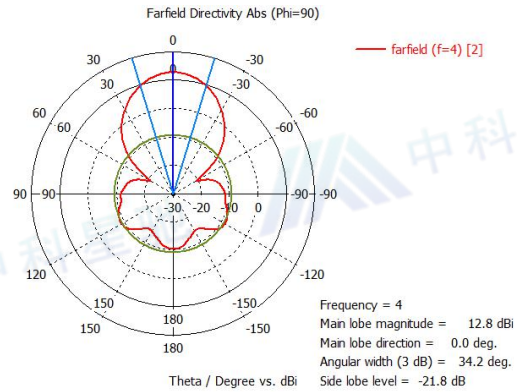
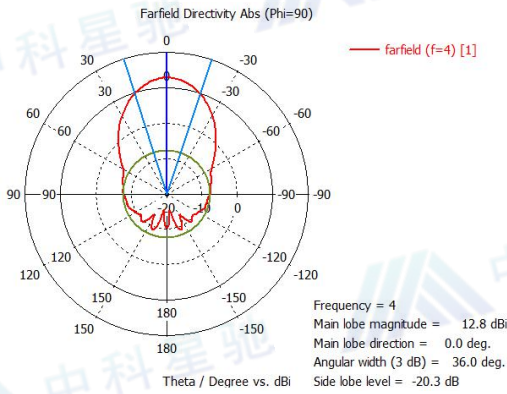

4GHz

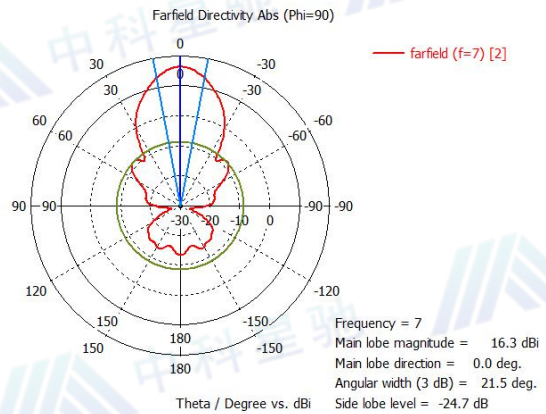
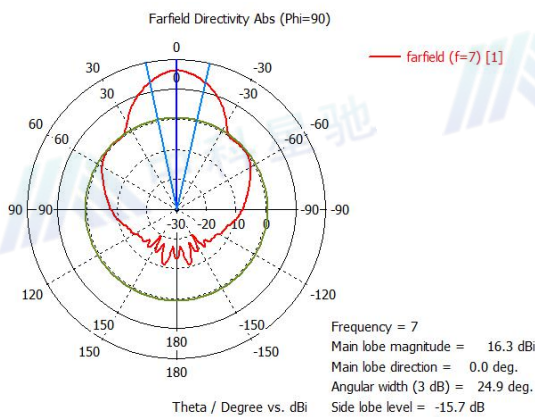



成都中科星驰科技有限公司

7GHz

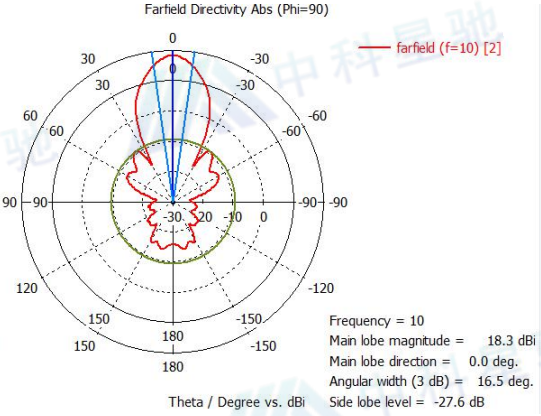
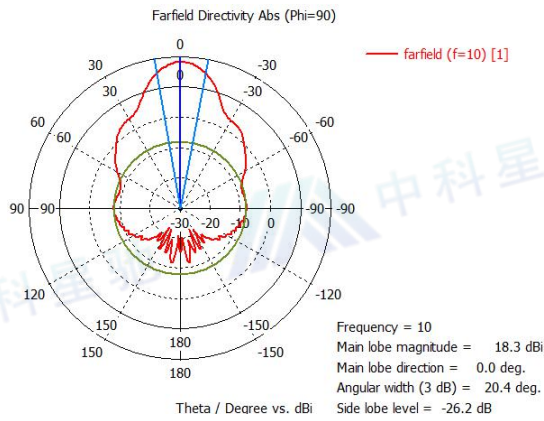

10GHz

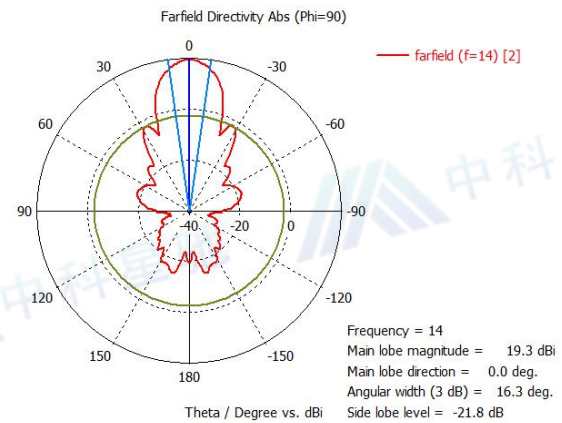
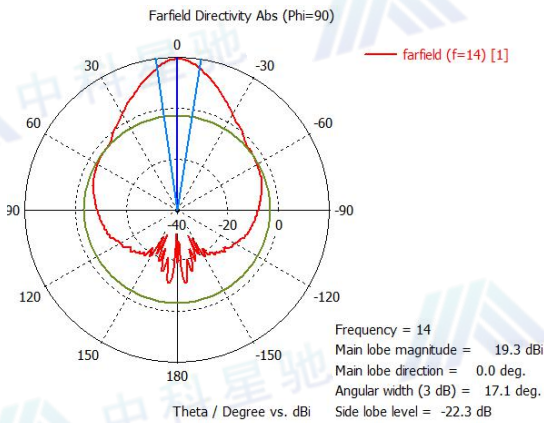

14GHz

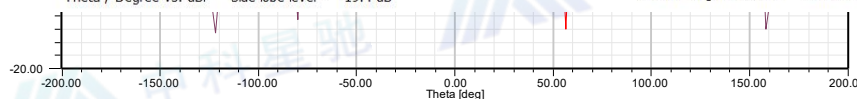
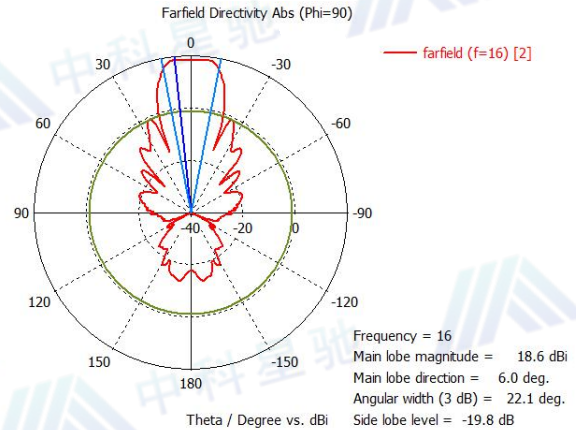
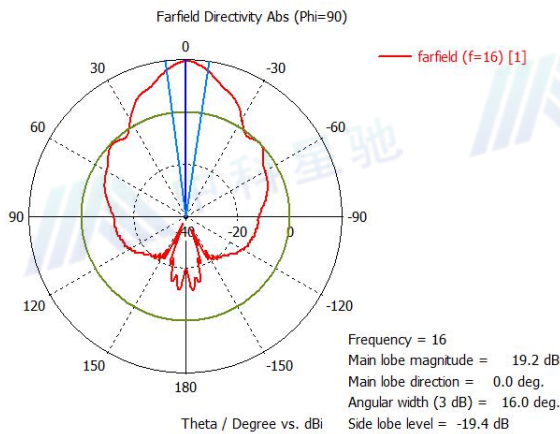



成都中科星驰科技有限公司

16GHz

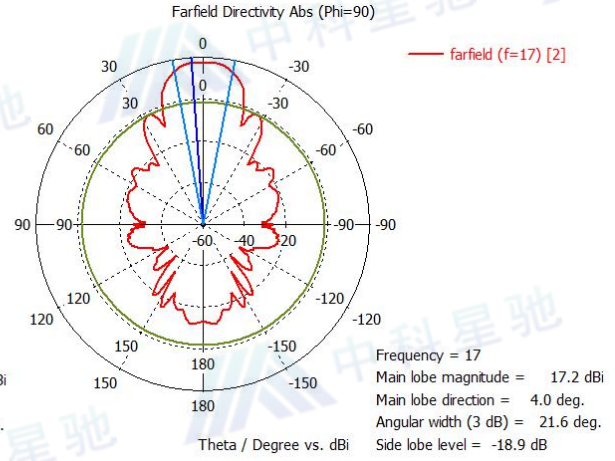
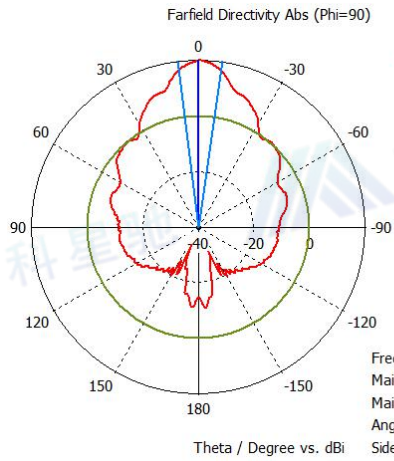

17GHz

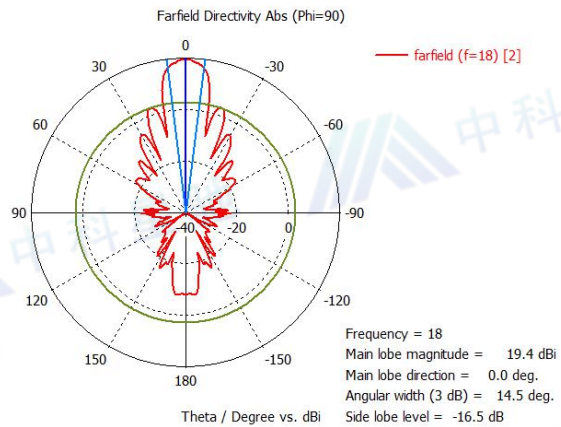
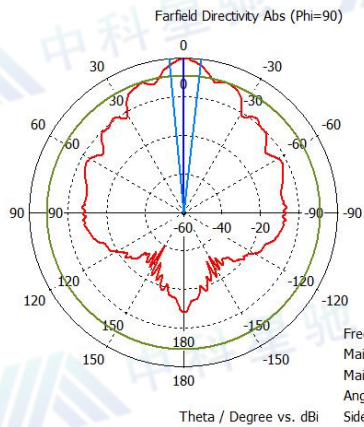

18GHz