



成都中科星驰科技有限公司

技术规格书

双极化喇叭天线

| 项目 | 指标 | 单位 |
|------|---------------|-----|
| 型号 | ZK-SJLB240500 | |
| 频率 | 24-50 | GHz |
| 增益 | 10 典型值. | dB |
| 驻波 | 2 典型值. | |
| 极化方式 | 双线极化 | |
| 接头 | 1.85mm | |
| 功率 | 10 最大 | |
| 材料 | 铝 | |
| 颜色 | 海灰色 | |
| 尺寸 | 31*17*17 | 毫米 |

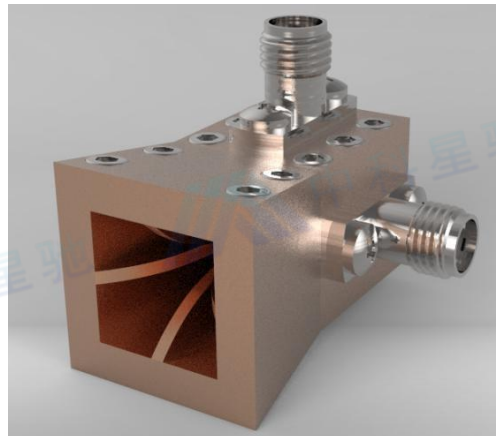



成都中科星驰科技有限公司

外形图:

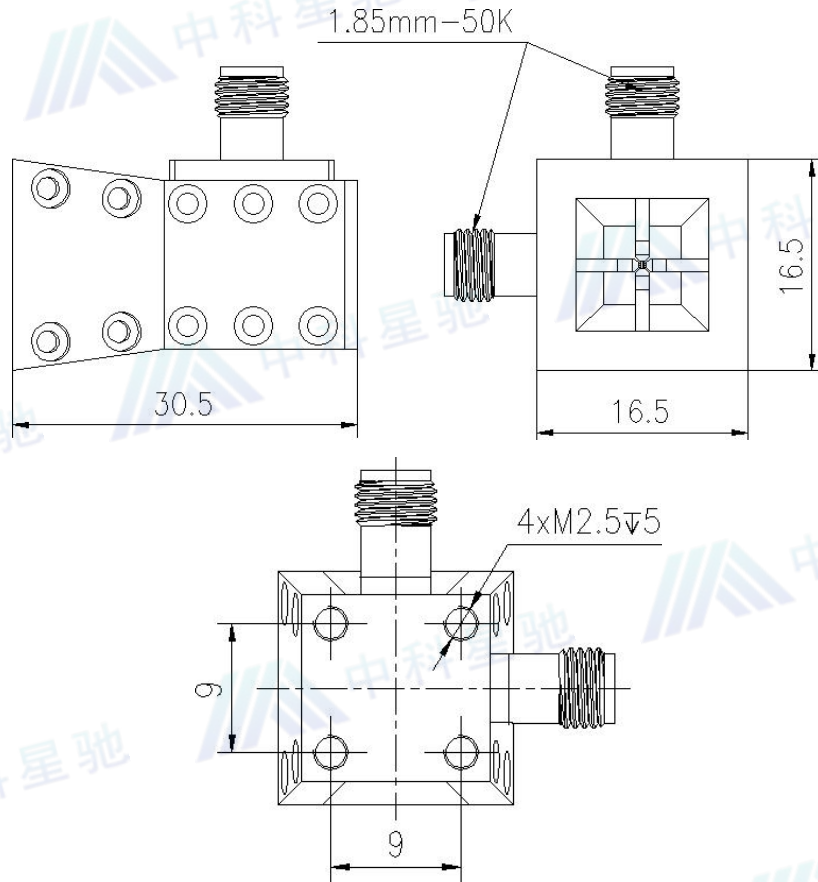

驻波:

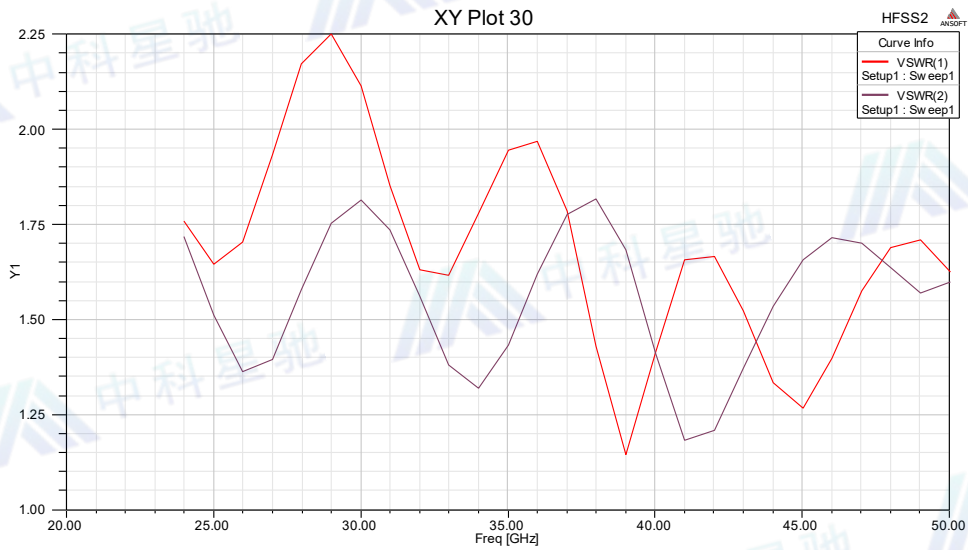



成都中科星驰科技有限公司

增益方向图:

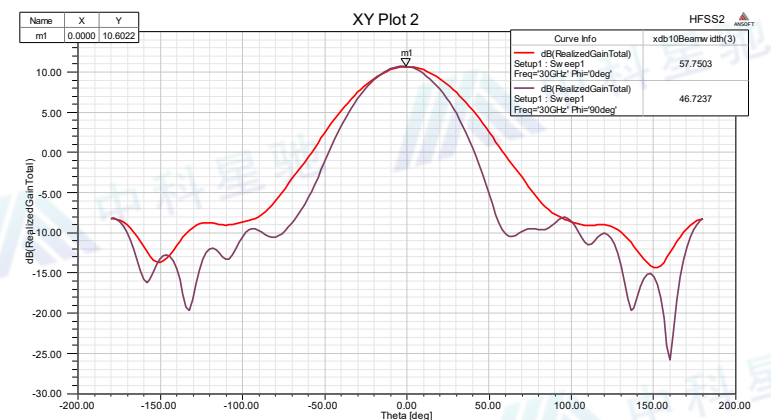
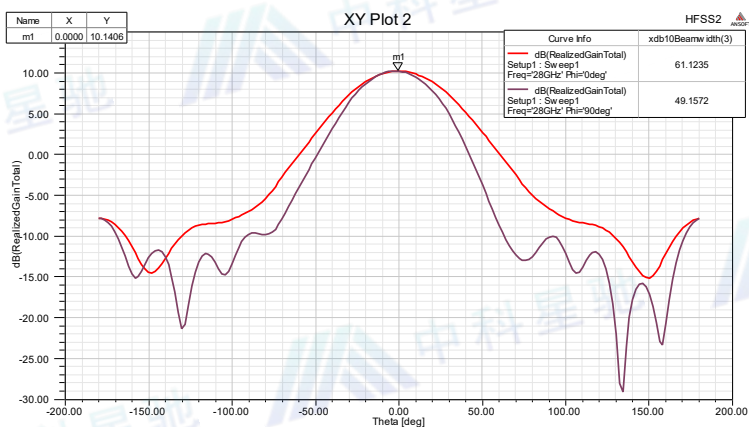
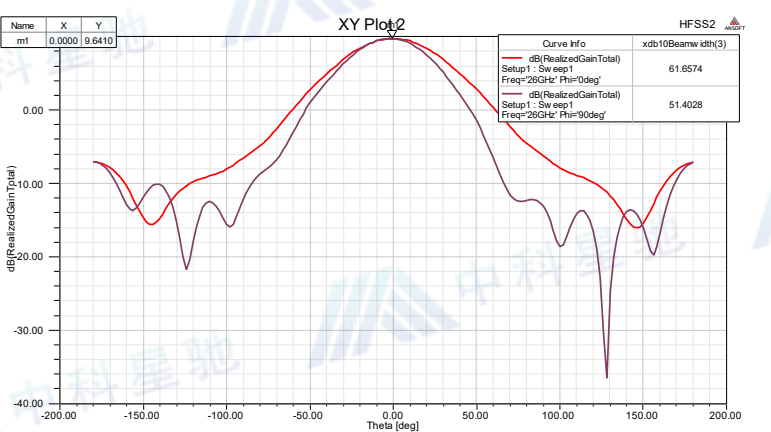
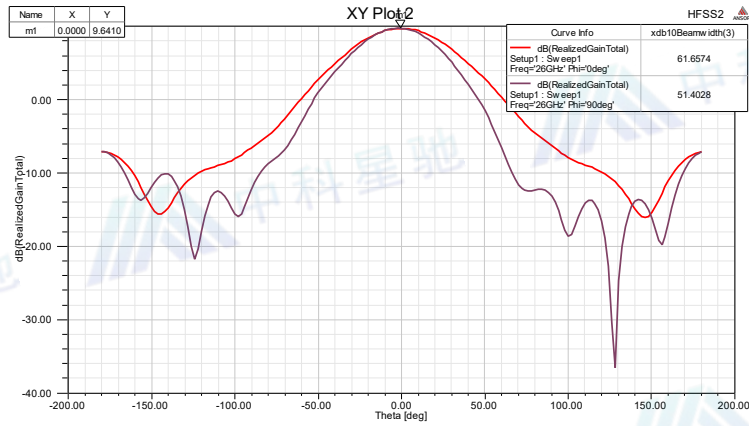
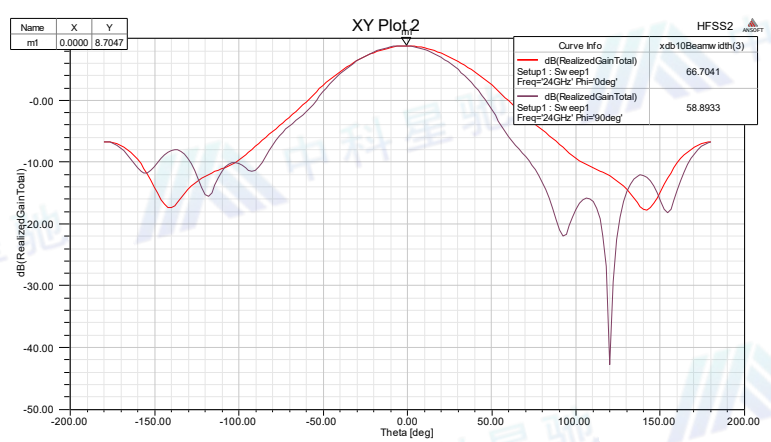
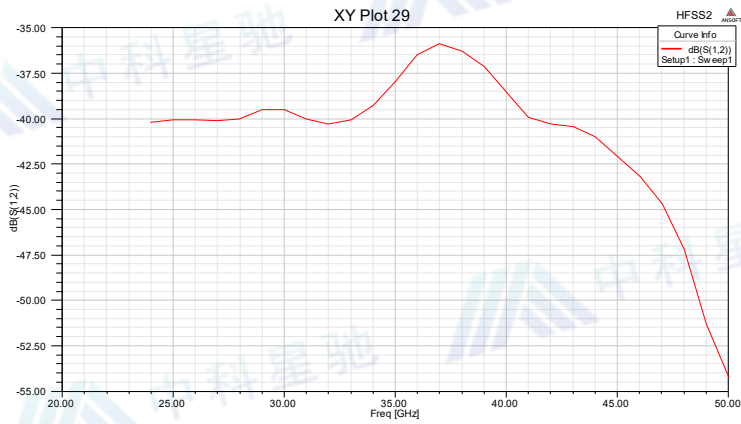



成都中科星驰科技有限公司

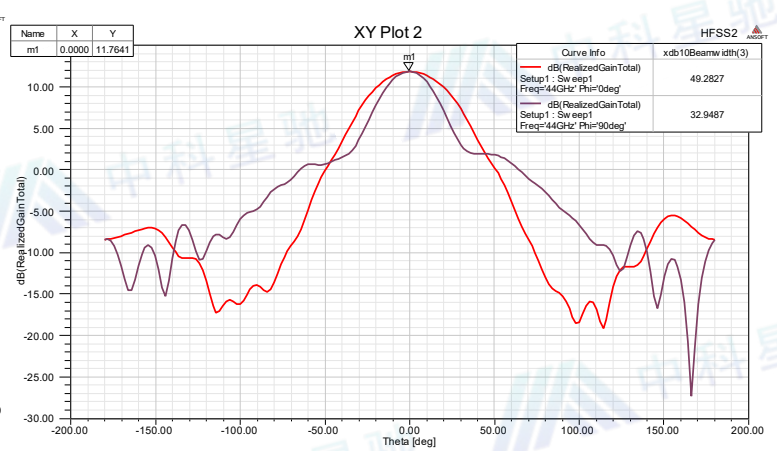
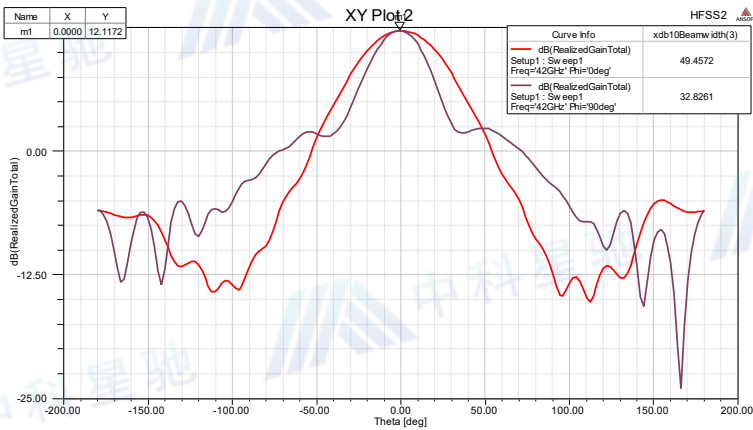
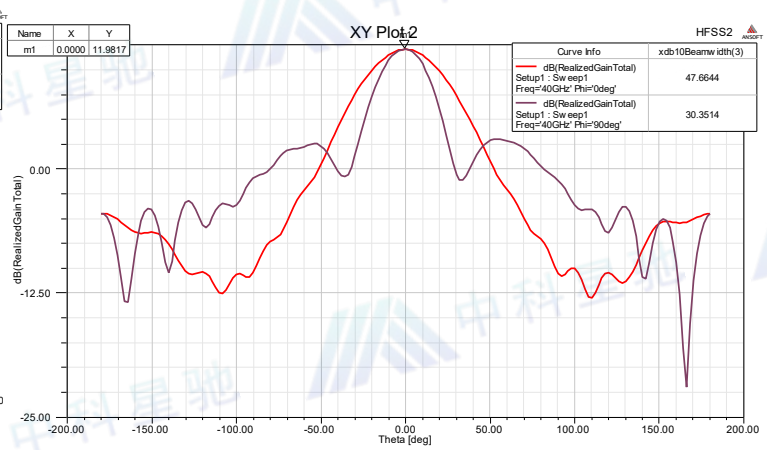
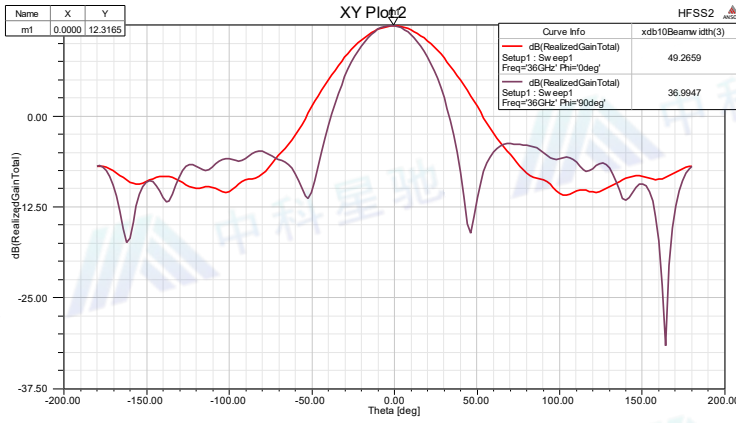
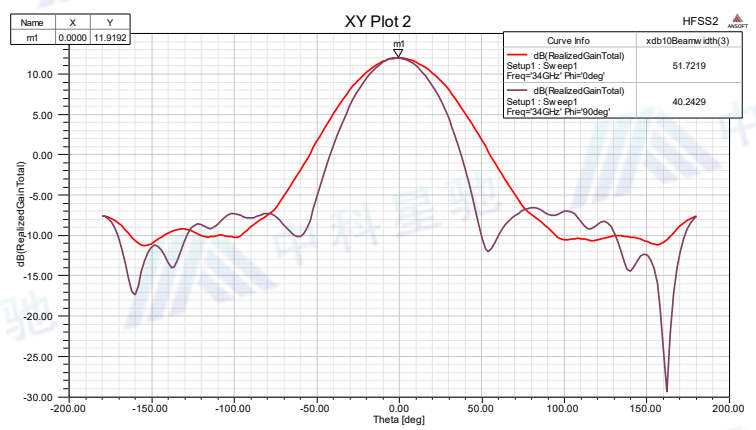
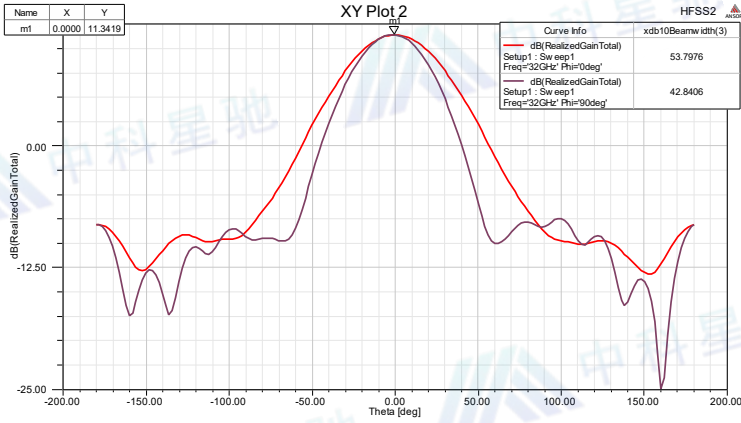



成都中科星驰科技有限公司

